



L87 LIGHTING SYSTEM

LED

The L87 Lighting System offers the ultimate in flexibility.

It is a suspended, pre-wired lighting system incorporating an upper section to the extrusion which can be utilised for extra segregated cabling or for an uplighting element.

The downward section can incorporate seamless lit sections, individual sections, 3 circuit track, lighting sensors and emergency lighting.

L87 can be manufactured in various lengths and configurations allowing clients to tailor the system to suit the demands of the scheme.

Delivered to site fully assembled, it can be produced in units up to 4.8m long, aiding installation time and costs.

To specify a system please provide a dimensioned layout drawing with suspension lengths and we will provide a layout drawing with part numbers.

- Predicted lifetime >50,000 hours.
- Standard ITAB Prolight LED warranty (see page 161).

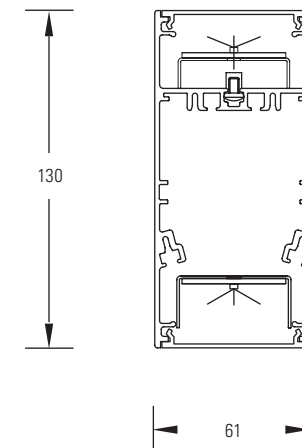



SPECIFICATION	
Body:	Extruded aluminium finished in epoxy powder coated white (RAL 9010) or silver (RAL9006) as standard. Special colours are available on request.
Diffuser:	Extruded opalised polycarbonate.
Installation:	Suspended via adjustable single point steel wire suspension kits.
Bends:	Solid bends are available.
Wiring:	A 7-way wiring loom which caters for mains and dimming control with plug in terminal blocks every 700mm. Each circuit can be selected via adjustable contacts on the plugs.
LED's:	.Philips Fortimo LED Line 1Row 280mm boards with nominal output of 3,900 lumens per metre. Other preset outputs are available in the range 2,300 – 4,600 lumens per metre.
Drivers:	Philips drivers are supplied and are available in fixed output, DALI or DALI touch and dim (Switchdim) operation.
Controls:	Lighting controls and sensors can be incorporated, please contact us for further information.
Emergency:	Integral 3 hour maintained emergency lighting packs are available. LED emergency units can also be incorporated.
Suspension:	Supported via stainless steel suspension wire and fixings.

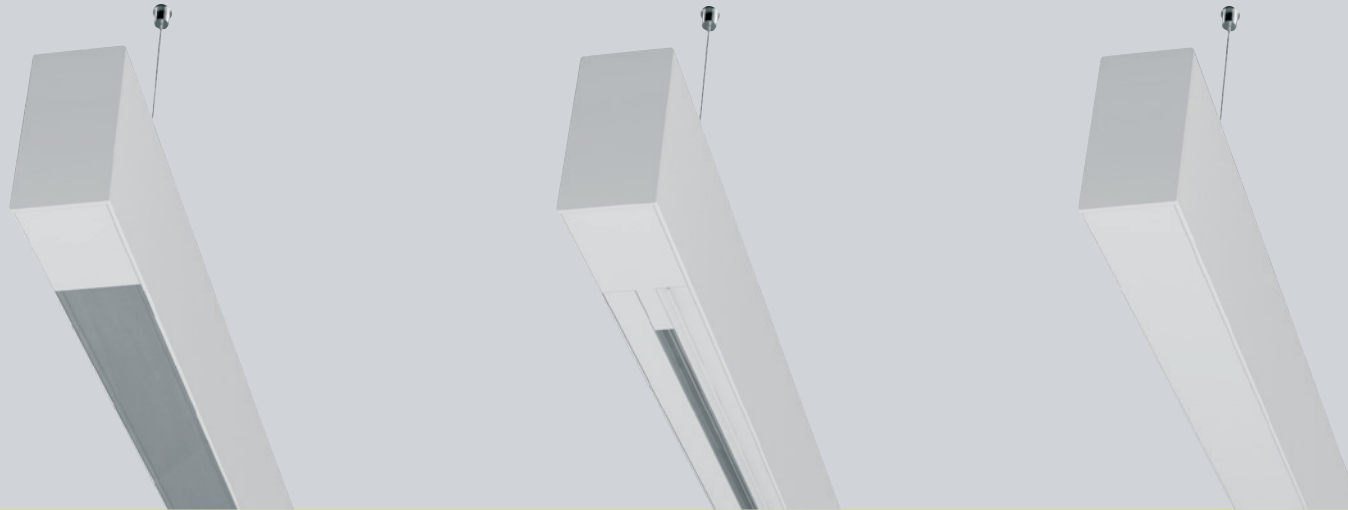

L87 LIGHTING SYSTEM

LED

**Direct/
Indirect**

**Track/
Indirect**

**Infill/
Indirect**

**Direct/Segregated
Cabling**

**Track/Segregated
Cabling**

**Infill/Segregated
Cabling**

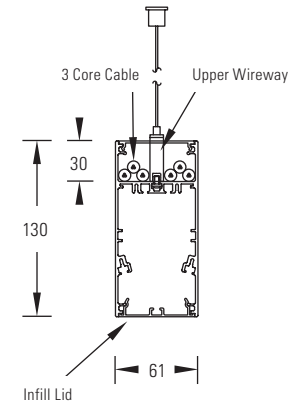
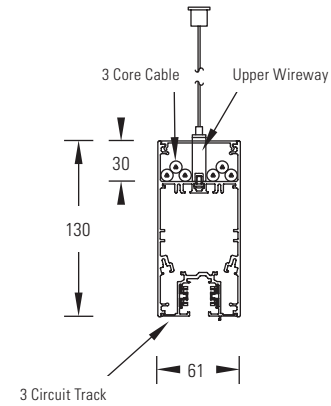
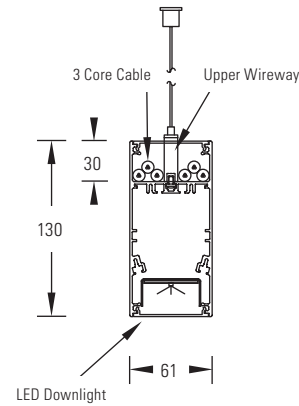
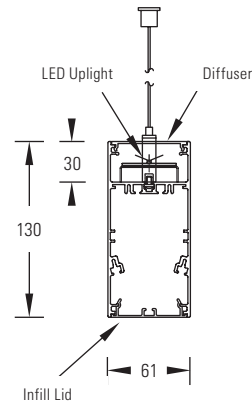
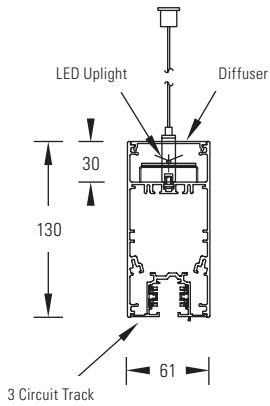
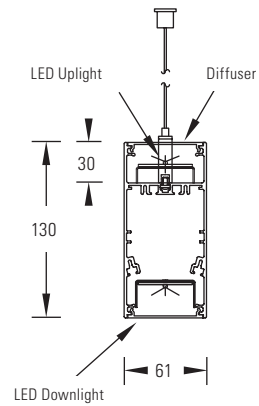

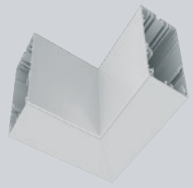

L Connector

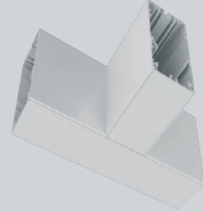

T Connector

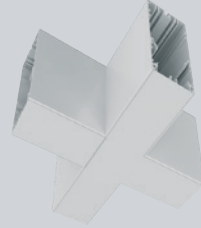

X Connector



L87 ACCESSORIES

Bends

- L87 solid bends for suspended and recessed versions.
- Includes blank infill plates.

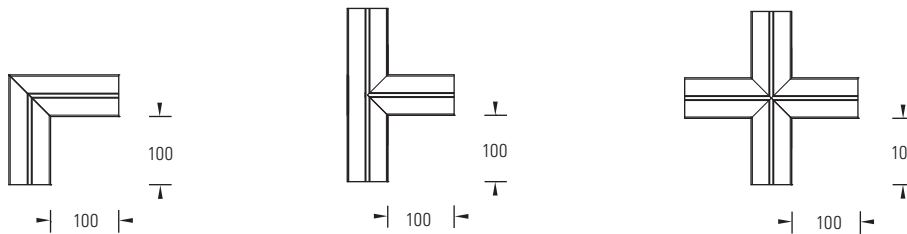

Suspensions

- Single point adjustable steel wire suspensions.

